



**BOREAS
DESIGN**

MEASURE, PROJECT AND IMPLEMENT

MODULAR KITCHEN

C A B I N E T S

Change starts in the kitchen

**QUALITY
PRACTICAL
ECONOMIC
FAST**



WHO WE ARE ?

Our company produces and assembles kitchen cabinets and bathroom cabinets. Our company, which is the leader in this branch, has succeeded in gaining the trust of end consumer or entrepreneur companies with its managers and technical team, who adopt quality management as a lifestyle and approach the issues professionally, specialized in their business. In our working area, we are ready to meet and assist for the commercial and technical issues that you may require in your projects.



OUR MISSION

Our mission is to create value for our customers through reliability and innovation, and to be the most successful furniture company in the industry in providing the best customer experience.

OUR VISION

Our vision is to provide value for money and comfort, to meet the expectations of the customers with the highest quality, first quality designs, and to be an international manufacturer that can provide innovative, high-quality products.

BASIC VALUES

Innovation: Forward thinking, planning and expanding our horizons,

Quality: We want to create services and products that we are proud to stand behind.

Teamwork: From the supplier to our valued customer, we all succeed together.

Customer satisfaction: We develop relationships that make a positive difference in our lives.

Happiness: Creating a better daily life for many people.

Company's liability : We are all responsible for meeting our commitments and integrity (corporate liability)



PRODUCTS

BASE CABINET

WALL CABINET 60 CM

WALL CABINET 72 CM

WALL CABINET 90 CM

TALL CABINET

SUPPLEMENTARY PRODUCTS

MATERIAL AND COLOUR OPTIONS

BASE CABINET





**BOREAS
DESIGN**

MEASURE, PROJECT AND IMPLEMENT

BASE CABINET

MODULE CODE	WIDTH	HEIGHT	DEPTH
AD01-6-30-24	150	726	560
AD01-8-30-24	200	726	560
AD01-10-30-24	250	726	560
AD01-12-30-24	300	726	560
AD01-14-30-24	350	726	560
AD01-16-30-24	400	726	560
AD01-18-30-24	450	726	560
AD01-20-30-24	500	726	560
AD01-22-30-24	550	726	560
AD01-24-30-24	600	726	560

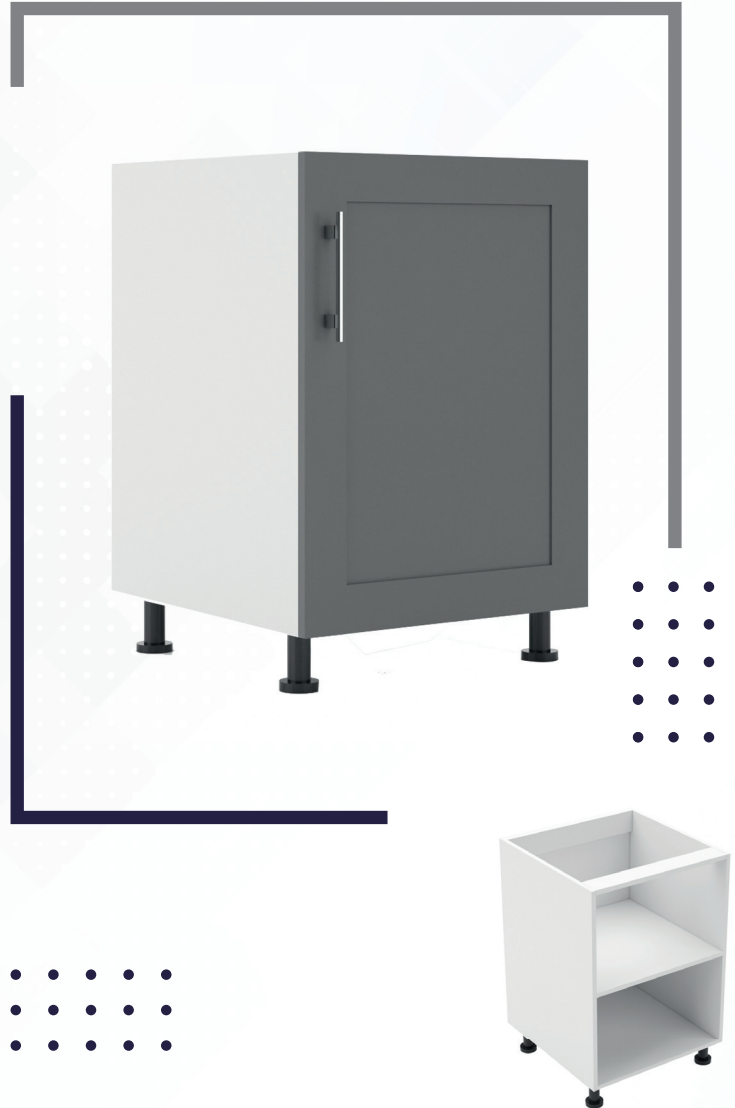



**BOREAS
DESIGN**

MEASURE, PROJECT AND IMPLEMENT

BASE CABINET

MODULE CODE	WIDTH	HEIGHT	DEPTH
AD02-24-30-24	600	726	560
AD02-26-30-24	650	726	560
AD02-28-30-24	700	726	560
AD02-30-30-24	750	726	560
AD02-32-30-24	800	726	560
AD02-34-30-24	850	726	560
AD02-36-30-24	900	726	560
AD02-38-30-24	950	726	560
AD02-40-30-24	1000	726	560





**BOREAS
DESIGN**

MEASURE, PROJECT AND IMPLEMENT

CABINET WITHOUT DOORS

MODULE CODE	WIDTH	HEIGHT	DEPTH
ADK-6-30-24	150	726	560
ADK-8-30-24	200	726	560
ADK-10-30-24	250	726	560
ADK-12-30-24	300	726	560
ADK-14-30-24	350	726	560
ADK-16-30-24	400	726	560





**BOREAS
DESIGN**

MEASURE, PROJECT AND IMPLEMENT

CABINET WITH SINGLE DRAWER

MODULE CODE	WIDTH	HEIGHT	DEPTH
CD01-12-30-24	300	726	560
CD01-14-30-24	350	726	560
CD01-16-30-24	400	726	560
CD01-18-30-24	450	726	560
CD01-20-30-24	500	726	560





**BOREAS
DESIGN**

MEASURE, PROJECT AND IMPLEMENT

CABINET WITH SINGLE DRAWER

MODULE CODE	WIDTH	HEIGHT	DEPTH
CD01-24-30-24	600	726	560
CD01-28-30-24	700	726	560
CD01-30-30-24	750	726	560
CD01-32-30-24	800	726	560
CD01-34-30-24	850	726	560
CD01-36-30-24	900	726	560
CD01-40-30-24	1000	726	560





**BOREAS
DESIGN**

MEASURE, PROJECT AND IMPLEMENT

CABINET WITH TWO DRAWERS

MODULE CODE	WIDTH	HEIGHT	DEPTH
CD02-12-30-24	300	726	560
CD02-14-30-24	350	726	560
CD02-16-30-24	400	726	560
CD02-18-30-24	450	726	560
CD02-20-30-24	500	726	560
CD02-24-30-24	600	726	560
CD02-28-30-24	700	726	560
CD02-30-30-24	750	726	560
CD02-32-30-24	800	726	560
CD02-34-30-24	850	726	560
CD02-36-30-24	900	726	560
CD02-40-30-24	1000	726	560

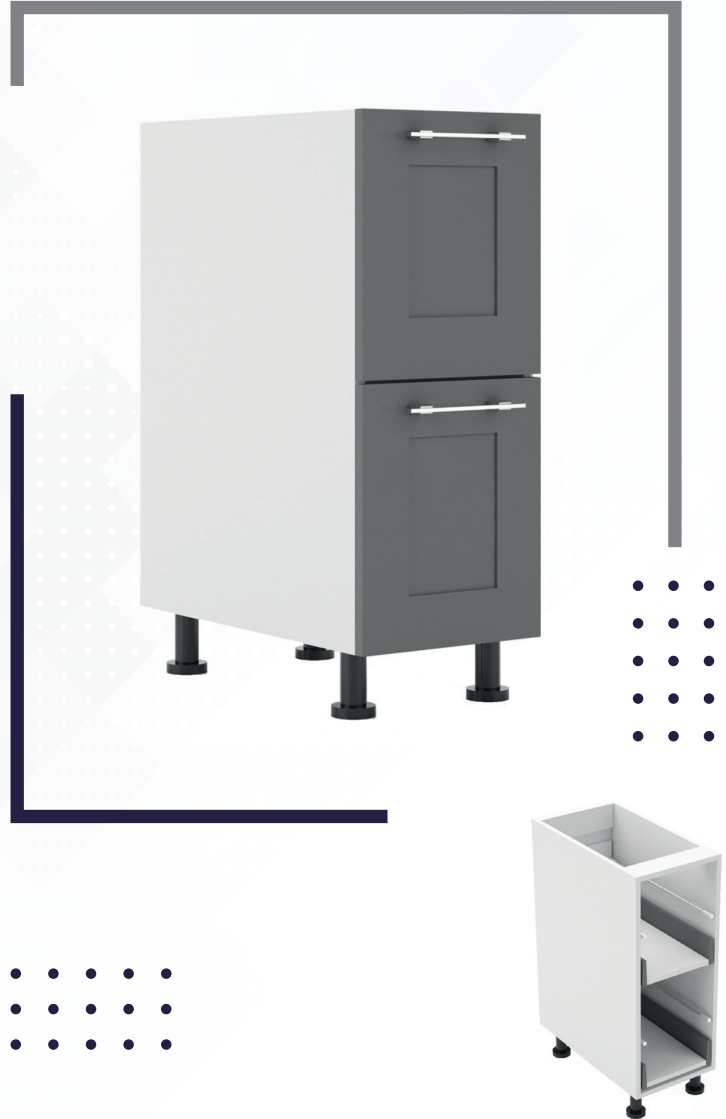



**BOREAS
DESIGN**

MEASURE, PROJECT AND IMPLEMENT

CABINET WITH THREE DRAWERS

MODULE CODE	WIDTH	HEIGHT	DEPTH
CD03-12-30-24	300	726	560
CD03-14-30-24	350	726	560
CD03-16-30-24	400	726	560
CD03-18-30-24	450	726	560
CD03-20-30-24	500	726	560
CD03-24-30-24	600	726	560
CD03-28-30-24	700	726	560
CD03-30-30-24	750	726	560
CD03-32-30-24	800	726	560
CD03-34-30-24	850	726	560
CD03-36-30-24	900	726	560
CD03-40-30-24	1000	726	560





**BOREAS
DESIGN**

MEASURE, PROJECT AND IMPLEMENT

SINK BASE CABINET

MODULE CODE	WIDTH	HEIGHT	DEPTH
ED01-20-30-24	500	726	560
ED01-24-30-24	600	726	560





**BOREAS
DESIGN**

MEASURE, PROJECT AND IMPLEMENT

SINK BASE CABINET

MODULE CODE	WIDTH	HEIGHT	DEPTH
ED02-28-30-24	700	726	560
ED02-30-30-24	750	726	560
ED02-32-30-24	800	726	560
ED02-34-30-24	850	726	560
ED02-36-30-24	900	726	560
ED02-40-30-24	1000	726	560
ED02-44-30-24	1100	726	560
ED02-48-30-24	1200	726	560





**BOREAS
DESIGN**

MEASURE, PROJECT AND IMPLEMENT

OVEN CABINET

MODULE CODE	WIDTH	HEIGHT	DEPTH
AFD01-24-30-24	600	726	560





**BOREAS
DESIGN**

MEASURE, PROJECT AND IMPLEMENT

BLIND CORNER BASE CABINET

MODULE CODE	WIDTH	HEIGHT	DEPTH
KKD01-42-30-24	1050	726	560
KKD01-44-30-24	1100	726	560
KKD01-48-30-24	1200	726	560





**BOREAS
DESIGN**

MEASURE, PROJECT AND IMPLEMENT

BLIND CORNER BASE CABINET

MODULE CODE	WIDTH	HEIGHT	DEPTH
KKD02-52-30-24	1300	726	560
KKD02-56-30-24	1400	726	560
KKD02-59-30-24	1500	726	560





**BOREAS
DESIGN**

MEASURE, PROJECT AND IMPLEMENT

L CORNER BASE CABINET

MODULE CODE	WIDTH	HEIGHT	DEPTH
LKD02-36-30-36	900	726	560





**BOREAS
DESIGN**

MEASURE, PROJECT AND IMPLEMENT

ANGLED FINISH BASE CABINET

MODULE CODE	WIDTH	HEIGHT	DEPTH
ABD01-12-30-24-12	300	726	560



WALL CABINET 60 CM





**BOREAS
DESIGN**

MEASURE, PROJECT AND IMPLEMENT

WALL CABINET

MODULE CODE	WIDTH	HEIGHT	DEPTH
UD01M-6-24-13	150	600	330
UD01M-8-24-13	200	600	330
UD01M-10-24-13	250	600	330
UD01M-12-24-13	300	600	330
UD01M-14-24-13	350	600	330
UD01M-16-24-13	400	600	330
UD01M-18-24-13	450	600	330
UD01M-20-24-13	500	600	330
UD01M-22-24-13	550	600	330
UD01M-24-24-13	600	600	330





**BOREAS
DESIGN**

MEASURE, PROJECT AND IMPLEMENT

WALL CABINET

MODULE CODE	WIDTH	HEIGHT	DEPTH
UD02M-24-24-13	600	600	330
UD02M-28-24-13	700	600	330
UD02M-30-24-13	750	600	330
UD02M-32-24-13	800	600	330
UD02M-34-24-13	850	600	330
UD02M-36-24-13	900	600	330
UD02M-40-24-13	1000	600	330





**BOREAS
DESIGN**

MEASURE, PROJECT AND IMPLEMENT

WALL WITHOUT DOORS

MODULE CODE	WIDTH	HEIGHT	DEPTH
UDKM-6-24-13	150	600	330
UDKM-8-24-13	200	600	330
UDKM-10-24-13	250	600	330
UDKM-12-24-13	300	600	330
UDKM-14-24-13	350	600	330
UDKM-16-24-13	400	600	330





**BOREAS
DESIGN**

MEASURE, PROJECT AND IMPLEMENT

LIFT-UP WALL CABINET

MODULE CODE	WIDTH	HEIGHT	DEPTH
YKK01M-24-24-13	600	600	330
YKK01M-28-24-13	700	600	330
YKK01M-30-24-13	750	600	330
YKK01M-32-24-13	800	600	330
YKK01M-36-24-13	900	600	330
YKK01M-40-24-13	1000	600	330





**BOREAS
DESIGN**

MEASURE, PROJECT AND IMPLEMENT

BLIND CORNER WALL CABINET

MODULE CODE	WIDTH	HEIGHT	DEPTH
UKK01M-26-24-13	650	600	330
UKK01M-28-24-13	700	600	330
UKK01M-30-24-13	750	600	330
UKK01M-32-24-13	800	600	330
UKK01M-34-24-13	850	600	330





**BOREAS
DESIGN**

MEASURE, PROJECT AND IMPLEMENT

BLIND CORNER WALL CABINET

MODULE CODE	WIDTH	HEIGHT	DEPTH
UKK02M-36-24-13	900	600	330
UKK02M-38-24-13	950	600	330
UKK02M-40-24-13	1000	600	330





**BOREAS
DESIGN**

MEASURE, PROJECT AND IMPLEMENT

L CORNER WALL CABINET

MODULE CODE	WIDTH	HEIGHT	DEPTH
ULK01M-24-24-13	600-600	600	330

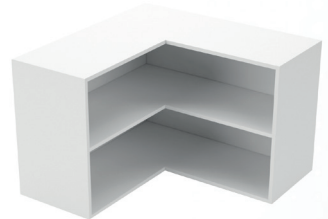



**BOREAS
DESIGN**

MEASURE, PROJECT AND IMPLEMENT

FAN WALL CABINET

MODULE CODE	WIDTH	HEIGHT	DEPTH
ASPO2M-24-21-13T	600	600	330





**BOREAS
DESIGN**

MEASURE, PROJECT AND IMPLEMENT

ANGLED CORNER WALL CABINET

MODULE CODE	WIDTH	HEIGHT	DEPTH
UAD01M-24-24-24	600	600	330





**BOREAS
DESIGN**

MEASURE, PROJECT AND IMPLEMENT

ANGLED FINISH WALL CORNER CABINET

MODULE CODE	WIDTH	HEIGHT	DEPTH
UABD01M-12-24-13	300	600	330



WALL CABINET 72 CM





**BOREAS
DESIGN**

MEASURE, PROJECT AND IMPLEMENT

WALL CABINET

MODULE CODE	WIDTH	HEIGHT	DEPTH
UD01-6-30-13	150	720	330
UD01-8-30-13	200	720	330
UD01-10-30-13	250	720	330
UD01-12-30-13	300	720	330
UD01-14-30-13	350	720	330
UD01-16-30-13	400	720	330
UD01-18-30-13	450	720	330
UD01-20-30-13	500	720	330
UD01-22-30-13	550	720	330
UD01-24-30-13	600	720	330





**BOREAS
DESIGN**

MEASURE, PROJECT AND IMPLEMENT

WALL CABINET

MODULE CODE	WIDTH	HEIGHT	DEPTH
UD02-24-30-13	600	720	330
UD02-28-30-13	700	720	330
UD02-30-30-13	750	720	330
UD02-32-30-13	800	720	330
UD02-34-30-13	850	720	330
UD02-36-30-13	900	720	330
UD02-40-30-13	1000	720	330





**BOREAS
DESIGN**

MEASURE, PROJECT AND IMPLEMENT

WALL WITHOUT DOORS

MODULE CODE	WIDTH	HEIGHT	DEPTH
UDK-6-30-13	150	720	330
UDK-8-30-13	200	720	330
UDK-10-30-13	250	720	330
UDK-12-30-13	300	720	330
UDK-14-30-13	350	720	330
UDK-16-30-13	400	720	330





**BOREAS
DESIGN**

MEASURE, PROJECT AND IMPLEMENT

LIFT-UP WALL CABINET

MODULE CODE	WIDTH	HEIGHT	DEPTH
YKK01-24-30-13	600	720	330
YKK01-28-30-13	700	720	330
YKK01-30-30-13	750	720	330
YKK01-32-30-13	800	720	330
YKK01-36-30-13	900	720	330
YKK01-40-30-13	1000	720	330





**BOREAS
DESIGN**

MEASURE, PROJECT AND IMPLEMENT

LIFT-UP WALL CABINET

MODULE CODE	WIDTH	HEIGHT	DEPTH
YKK02-24-30-13	600	720	330
YKK02-28-30-13	700	720	330
YKK02-30-30-13	750	720	330
YKK02-32-30-13	800	720	330
YKK02-36-30-13	900	720	330
YKK02-40-30-13	1000	720	330





**BOREAS
DESIGN**

MEASURE, PROJECT AND IMPLEMENT

LIFT-UP WALL CABINET

MODULE CODE	WIDTH	HEIGHT	DEPTH
YKK03-24-30-13	600	720	330
YKK03-28-30-13	700	720	330
YKK03-30-30-13	750	720	330
YKK03-32-30-13	800	720	330
YKK03-36-30-13	900	720	330
YKK03-40-30-13	1000	720	330





**BOREAS
DESIGN**

MEASURE, PROJECT AND IMPLEMENT

BLIND CORNER WALL CABINET

MODULE CODE	WIDTH	HEIGHT	DEPTH
UKK01-26-30-13	650	720	330
UKK01-28-30-13	700	720	330
UKK01-30-30-13	750	720	330
UKK01-32-30-13	800	720	330
UKK01-34-30-13	850	720	330





**BOREAS
DESIGN**

MEASURE, PROJECT AND IMPLEMENT

BLIND CORNER WALL CABINET

MODULE CODE	WIDTH	HEIGHT	DEPTH
UKK02-36-30-13	900	720	330
UKK02-38-30-13	950	720	330
UKK02-40-30-13	1000	720	330





**BOREAS
DESIGN**

MEASURE, PROJECT AND IMPLEMENT

L CORNER WALL CABINET

MODULE CODE	WIDTH	HEIGHT	DEPTH
ULK01-24-30-24	600	720	330

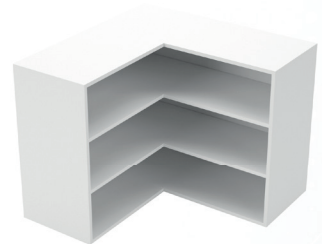



**BOREAS
DESIGN**

MEASURE, PROJECT AND IMPLEMENT

FAN WALL CABINET

MODULE CODE	WIDTH	HEIGHT	DEPTH
ASPD2-24-26-13	600	650	330





**BOREAS
DESIGN**

MEASURE, PROJECT AND IMPLEMENT

CANOPY WALL CABINET

MODULE CODE	WIDTH	HEIGHT	DEPTH
DUD01-24-10-13	600	250	330
DUD01-28-10-13	700	250	330
DUD01-30-10-13	750	250	330





**BOREAS
DESIGN**

MEASURE, PROJECT AND IMPLEMENT

REFRIGERATOR WALL CABINET

MODULE CODE	WIDTH	HEIGHT	DEPTH
BUD01-30-10-24	750	250	560
BUD01-32-10-24	800	250	560
BUD01-36-10-24	900	250	560
BUD016-30-12-24	750	300	560
BUD016-32-12-24	800	300	560
BUD016-36-12-24	900	300	560





**BOREAS
DESIGN**

MEASURE, PROJECT AND IMPLEMENT

REFRIGERATOR WALL CABINET

MODULE CODE	WIDTH	HEIGHT	DEPTH
BUD02-30-10-24	750	250	560
BUD02-32-10-24	800	250	560
BUD02-36-10-24	900	250	560
BUD026-30-12-24	750	300	560
BUD026-32-12-24	800	300	560
BUD026-36-12-24	900	300	560

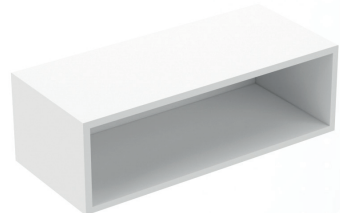



**BOREAS
DESIGN**

MEASURE, PROJECT AND IMPLEMENT

ANGLED CORNER WALL CABINET

MODULE CODE	WIDTH	HEIGHT	DEPTH
UAD01-24-30-24	600	720	330





**BOREAS
DESIGN**

MEASURE, PROJECT AND IMPLEMENT

ANGLED FINISH WALL CORNER CABINET

MODULE CODE	WIDTH	HEIGHT	DEPTH
UABD01-12-30-13	300	720	330



WALL CABINET 90 CM





**BOREAS
DESIGN**

MEASURE, PROJECT AND IMPLEMENT

WALL CABINET

MODULE CODE	WIDTH	HEIGHT	DEPTH
UD01H-6-35-13	150	900	330
UD01H-8-35-13	200	900	330
UD01H-10-35-13	250	900	330
UD01H-12-35-13	300	900	330
UD01H-14-35-13	350	900	330
UD01H-16-35-13	400	900	330
UD01H-18-35-13	450	900	330
UD01H-20-35-13	500	900	330
UD01H-22-35-13	550	900	330
UD01H-24-35-13	600	900	330





**BOREAS
DESIGN**

MEASURE, PROJECT AND IMPLEMENT

WALL CABINET

MODULE CODE	WIDTH	HEIGHT	DEPTH
UD02H-24-35-13	600	900	330
UD02H-28-35-13	700	900	330
UD02H-30-35-13	750	900	330
UD02H-32-35-13	800	900	330
UD02H-34-35-13	850	900	330
UD02H-36-35-13	900	900	330
UD02H-40-35-13	1000	900	330





**BOREAS
DESIGN**

MEASURE, PROJECT AND IMPLEMENT

WALL WITHOUT DOORS

MODULE CODE	WIDTH	HEIGHT	DEPTH
UDKH-6-35-13	150	900	330
UDKH-8-35-13	200	900	330
UDKH-10-35-13	250	900	330
UDKH-12-35-13	300	900	330
UDKH-14-35-13	350	900	330
UDKH-16-35-13	400	900	330





**BOREAS
DESIGN**

MEASURE, PROJECT AND IMPLEMENT

LIFT-UP WALL CABINET

MODULE CODE	WIDTH	HEIGHT	DEPTH
YKK01H-24-35-13	600	900	330
YKK01H-28-35-13	700	900	330
YKK01H-30-35-13	750	900	330
YKK01H-32-35-13	800	900	330
YKK01H-36-35-13	900	900	330
YKK01H-40-35-13	1000	900	330





**BOREAS
DESIGN**

MEASURE, PROJECT AND IMPLEMENT

LIFT-UP WALL CABINET

MODULE CODE	WIDTH	HEIGHT	DEPTH
YKK02H-24-35-13	600	900	330
YKK02H-28-35-13	700	900	330
YKK02H-30-35-13	750	900	330
YKK02H-32-35-13	800	900	330
YKK02H-36-35-13	900	900	330
YKK02H-40-35-13	1000	900	330





**BOREAS
DESIGN**

MEASURE, PROJECT AND IMPLEMENT

LIFT-UP WALL CABINET

MODULE CODE	WIDTH	HEIGHT	DEPTH
YKK03H-24-35-13	600	900	330
YKK03H-28-35-13	700	900	330
YKK03H-30-35-13	750	900	330
YKK03H-32-35-13	800	900	330
YKK03H-36-35-13	900	900	330
YKK03H-40-35-13	1000	900	330





**BOREAS
DESIGN**

MEASURE, PROJECT AND IMPLEMENT

BLIND CORNER WALL CABINET

MODULE CODE	WIDTH	HEIGHT	DEPTH
UKK01H-26-35-13	650	900	330
UKK01H-28-35-13	700	900	330
UKK01H-30-35-13	750	900	330
UKK01H-32-35-13	800	900	330
UKK01H-34-35-13	850	900	330





**BOREAS
DESIGN**

MEASURE, PROJECT AND IMPLEMENT

BLIND CORNER WALL CABINET

MODULE CODE	WIDTH	HEIGHT	DEPTH
UKK02H-36-35-13	900	900	330
UKK02H-38-35-13	950	900	330
UKK02H-40-35-13	1000	900	330





**BOREAS
DESIGN**

MEASURE, PROJECT AND IMPLEMENT

L CORNER WALL CABINET

MODULE CODE	WIDTH	HEIGHT	DEPTH
ULK01H-24-35-24	600	900	330

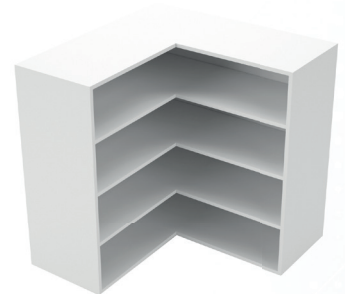



**BOREAS
DESIGN**

MEASURE, PROJECT AND IMPLEMENT

FAN WALL CABINET

MODULE CODE	WIDTH	HEIGHT	DEPTH
ASPO2H-24-33-13	600	850	330





**BOREAS
DESIGN**

MEASURE, PROJECT AND IMPLEMENT

CANOPY WALL CABINET

MODULE CODE	WIDTH	HEIGHT	DEPTH
DUD01H-24-12-13	600	300	330
DUD01H-28-12-13	700	300	330
DUD01H-30-12-13	750	300	330
DUD02H-24-16-13	600	400	330
DUD02H-28-16-13	700	400	330
DUD02H-30-16-13	750	400	330

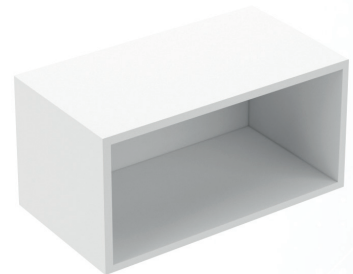



**BOREAS
DESIGN**

MEASURE, PROJECT AND IMPLEMENT

REFRIGERATOR WALL CABINET

MODULE CODE	WIDTH	HEIGHT	DEPTH
BUD01GH-30-18-24	750	450	560
BUD01GH-32-18-24	800	450	560
BUD01GH-36-18-24	900	450	560
BUD01H-30-16-24	750	400	560
BUD01H-32-16-24	800	400	560
BUD01H-36-16-24	900	400	560

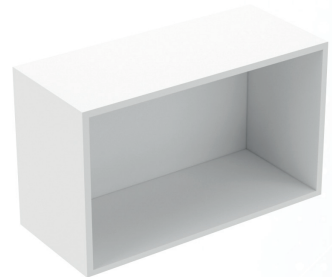



**BOREAS
DESIGN**

MEASURE, PROJECT AND IMPLEMENT

REFRIGERATOR WALL CABINET

MODULE CODE	WIDTH	HEIGHT	DEPTH
BUD026H-30-18-24	750	450	560
BUD026H-32-18-24	800	450	560
BUD026H-36-18-24	900	450	560
BUD02H-30-16-24	750	400	560
BUD02H-32-16-24	800	400	560
BUD02H-36-16-24	900	400	560

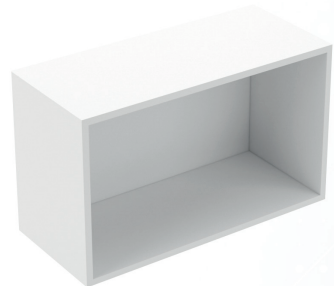



**BOREAS
DESIGN**

MEASURE, PROJECT AND IMPLEMENT

ANGLED CORNER WALL CABINET

MODULE CODE	WIDTH	HEIGHT	DEPTH
UAD01H-24-35-24	600	900	330





**BOREAS
DESIGN**

MEASURE, PROJECT AND IMPLEMENT

ANGLED FINISH WALL CORNER CABINET

MODULE CODE	WIDTH	HEIGHT	DEPTH
UABDO 1H-12-35-13	300	900	330



TALL CABINET





**BOREAS
DESIGN**

MEASURE, PROJECT AND IMPLEMENT

TALL KITCHEN CABINET

MODULE CODE	WIDTH	HEIGHT	DEPTH
BD01-14-80-24	350	2040	560
BD01-16-80-24	400	2040	560
BD01-18-80-24	450	2040	560
BD01-20-80-24	500	2040	560
BD01-24-80-24	600	2040	560
BD01H-14-86-24	350	2180	560
BD01H-16-86-24	400	2180	560
BD01H-18-86-24	450	2180	560
BD01H-20-86-24	500	2180	560
BD01H-24-86-24	600	2180	560





**BOREAS
DESIGN**

MEASURE, PROJECT AND IMPLEMENT

TALL KITCHEN CABINET

MODULE CODE	WIDTH	HEIGHT	DEPTH
BD02-14-80-24	350	2040	560
BD02-16-80-24	400	2040	560
BD02-18-80-24	450	2040	560
BD02-20-80-24	500	2040	560
BD02-24-80-24	600	2040	560
BD02H-14-86-24	350	2180	560
BD02H-16-86-24	400	2180	560
BD02H-18-86-24	450	2180	560
BD02H-20-86-24	500	2180	560
BD02H-24-86-24	600	2180	560





**BOREAS
DESIGN**

MEASURE, PROJECT AND IMPLEMENT

TALL KITCHEN CABINET

MODULE CODE	WIDTH	HEIGHT	DEPTH
BD03-14-80-24	350	2040	560
BD03-16-80-24	400	2040	560
BD03-18-80-24	450	2040	560
BD03-20-80-24	500	2040	560
BD03-24-80-24	600	2040	560
BD03H-14-86-24	350	2180	560
BD03H-16-86-24	400	2180	560
BD03H-18-86-24	450	2180	560
BD03H-20-86-24	500	2180	560
BD03H-24-86-24	600	2180	560

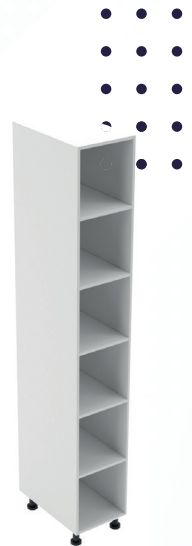



**BOREAS
DESIGN**

MEASURE, PROJECT AND IMPLEMENT

SEMI TALL KITCHEN CABINET

MODULE CODE	WIDTH	HEIGHT	DEPTH
YBD01-14-52-24	350	1320	560
YBD01-16-52-24	400	1320	560
YBD01-18-52-24	450	1320	560
YBD01-20-52-24	500	1320	560
YBD01-24-52-24	600	1320	560





**BOREAS
DESIGN**

MEASURE, PROJECT AND IMPLEMENT

TALL KITCHEN WITHOUT DOORS

MODULE CODE	WIDTH	HEIGHT	DEPTH
BDK-14-80-24	350	2040	560
BDK-16-80-24	400	2040	560
BDKH-14-86-24	350	2180	560
BDKH-16-86-24	400	2180	560





**BOREAS
DESIGN**

MEASURE, PROJECT AND IMPLEMENT

BUILT-IN OVEN TALL CABINET

MODULE CODE	WIDTH	HEIGHT	DEPTH
BFD01-24-80-24	600	2040	560
BFD01H-24-86-24	600	2180	560





**BOREAS
DESIGN**

MEASURE, PROJECT AND IMPLEMENT

BUILT-IN OVEN TALL CABINET

MODULE CODE	WIDTH	HEIGHT	DEPTH
BFD02-24-80-24	600	2040	560
BFD02H-24-86-24	600	2180	560





**BOREAS
DESIGN**

MEASURE, PROJECT AND IMPLEMENT

BUILT-IN OVEN TALL CABINET

MODULE CODE	WIDTH	HEIGHT	DEPTH
BFD03-24-80-24	600	2040	560
BFD03H-24-86-24	600	2180	560





**BOREAS
DESIGN**

MEASURE, PROJECT AND IMPLEMENT

BUILT-IN OVEN TALL CABINET

MODULE CODE	WIDTH	HEIGHT	DEPTH
BFD04-24-80-24	600	2040	560
BFD04H-24-86-24	600	2180	560





**BOREAS
DESIGN**

MEASURE, PROJECT AND IMPLEMENT

SEMI TALL BUILT-IN OVEN CABINET

MODULE CODE	WIDTH	HEIGHT	DEPTH
YFD01-24-52-24	600	1320	560





**BOREAS
DESIGN**

MEASURE, PROJECT AND IMPLEMENT

SEMI TALL BUILT-IN OVEN CABINET

MODULE CODE	WIDTH	HEIGHT	DEPTH
YFD02-24-52-24	600	1320	560





**BOREAS
DESIGN**

MEASURE, PROJECT AND IMPLEMENT

SEMI TALL BUILT-IN OVEN CABINET

MODULE CODE	WIDTH	HEIGHT	DEPTH
YFD03-24-52-24	600	1320	560





**BOREAS
DESIGN**

MEASURE, PROJECT AND IMPLEMENT

SEMI TALL BUILT-IN OVEN CABINET

MODULE CODE	WIDTH	HEIGHT	DEPTH
YFD04-24-52-24	600	1320	560





**BOREAS
DESIGN**

MEASURE, PROJECT AND IMPLEMENT

BUILT-IN OVEN-MICROWAVE CABINET

MODULE CODE	WIDTH	HEIGHT	DEPTH
BMFDD1-24-80-24	600	2040	560
BMFDD1H-24-86-24	600	2180	560





**BOREAS
DESIGN**

MEASURE, PROJECT AND IMPLEMENT

BUILT-IN REFRIGERATOR CABINET

MODULE CODE	WIDTH	HEIGHT	DEPTH
BAD01-24-80-24	600	2040	560



SUPPLEMENTARY PRODUCTS





**BOREAS
DESIGN**

MEASURE, PROJECT AND IMPLEMENT

BASE SIDE COVER PANEL

MODULE CODE	WIDTH	HEIGHT
AYK01-35-25	580	840

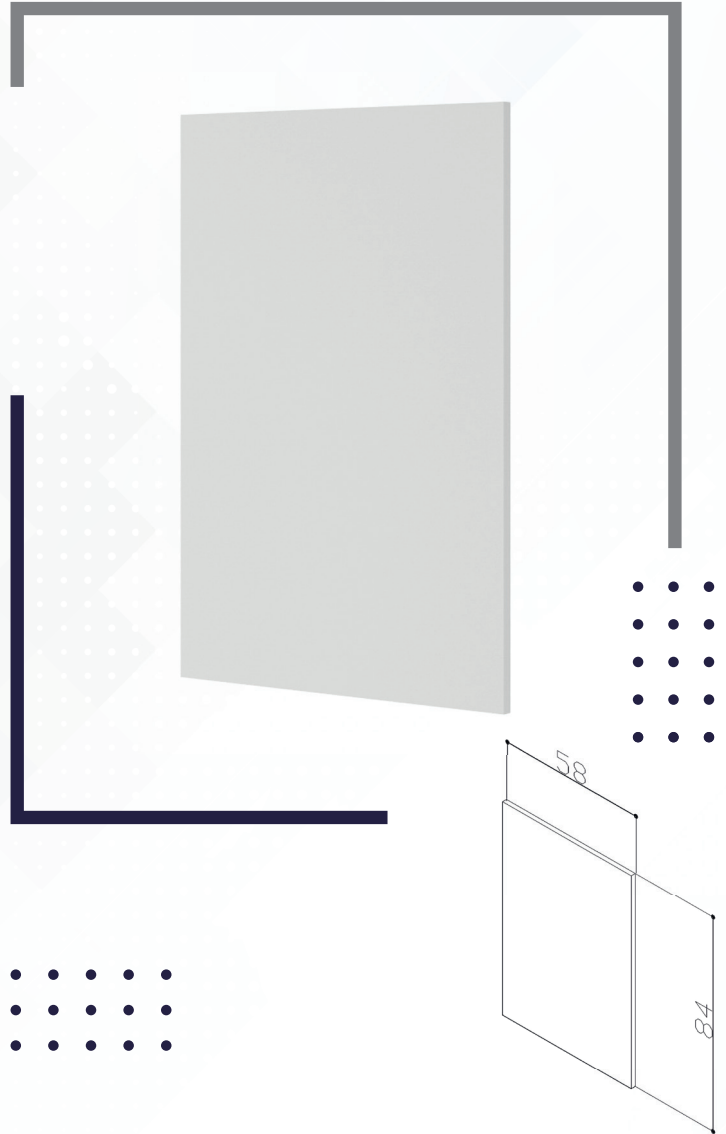



**BOREAS
DESIGN**

MEASURE, PROJECT AND IMPLEMENT

WALL SIDE COVER PANEL

MODULE CODE	WIDTH	HEIGHT
UYK01-30-14	350	720
UYK02-35-14	350	900
UYK03-24-14	350	600

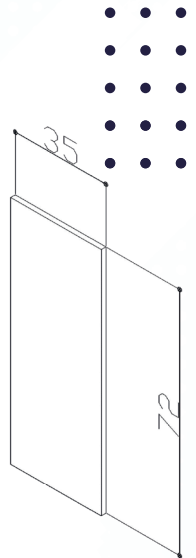



**BOREAS
DESIGN**

MEASURE, PROJECT AND IMPLEMENT

TALL CABINET SIDE COVER PANEL

MODULE CODE	WIDTH	HEIGHT
BDYK01-85-25	580	2160
BDYK02-92-25	580	2340

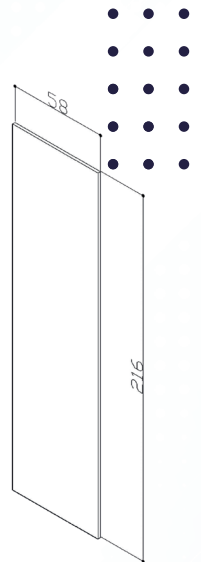



**BOREAS
DESIGN**

MEASURE, PROJECT AND IMPLEMENT

SEMI TALL CABINET COVER PANEL

MODULE CODE	WIDTH	HEIGHT
YBDK01-57-25	580	1450

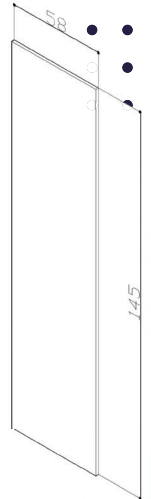



**BOREAS
DESIGN**

MEASURE, PROJECT AND IMPLEMENT

REFRIGERATOR SIDE PANEL

MODULE CODE	WIDTH	HEIGHT
BYP01-85-25	580	2160
BYP02-92-25	580	2340

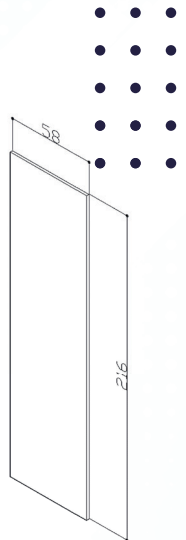



**BOREAS
DESIGN**

MEASURE, PROJECT AND IMPLEMENT

CANOPY WALL PANEL

MODULE CODE	WIDTH	HEIGHT
DA01-28-30	700	720
DA02-36-30	900	720
DA03-40-30	1000	720
DA04-28-24	700	600
DA05-36-24	900	600
DA06-40-24	1000	600
DA07-28-35	700	900
DA08-36-35	900	900
DA09-40-35	1000	900

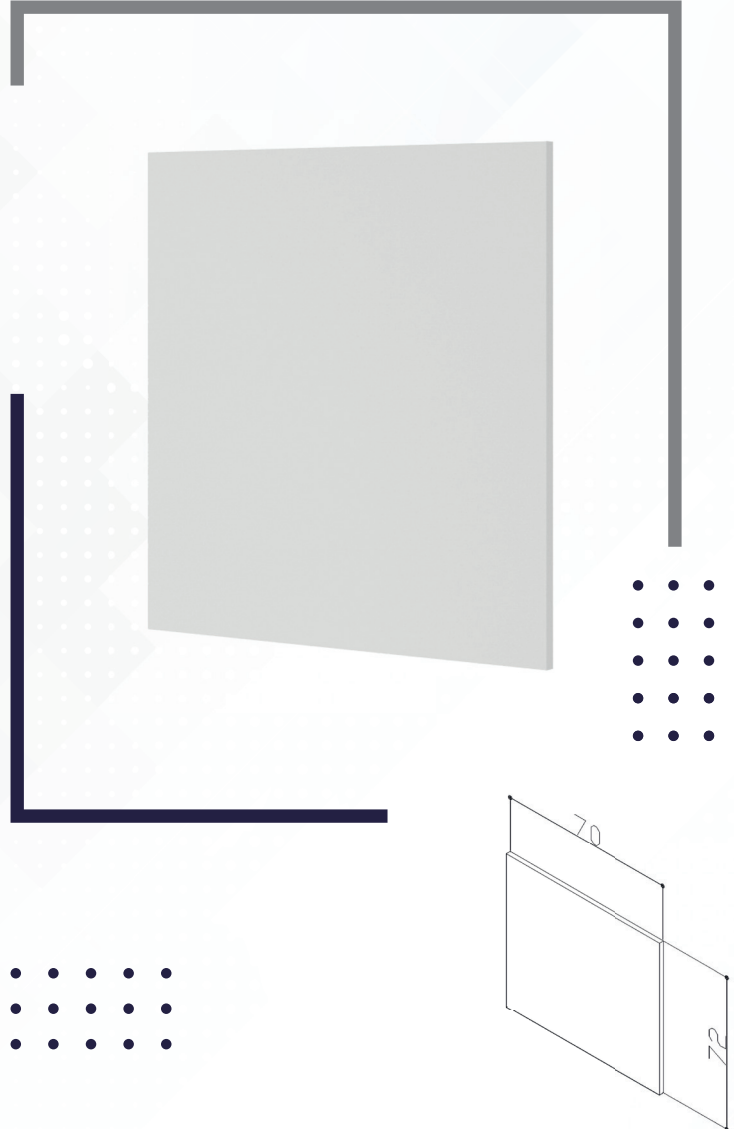



**BOREAS
DESIGN**

MEASURE, PROJECT AND IMPLEMENT

CANOPY UPPER PANEL

MODULE CODE	WIDTH	HEIGHT
DUP01-28-14	700	350
DUP02-30-14	750	350
DUP03-32-14	800	350
DUP04-34-14	850	350
DUP05-36-14	900	350
DUP06-38-14	950	350
DUP07-40-14	1000	350

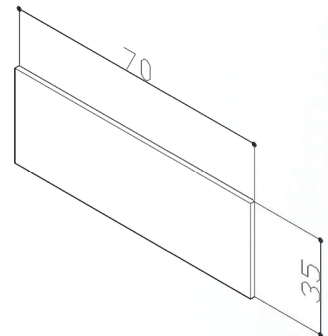



**BOREAS
DESIGN**

MEASURE, PROJECT AND IMPLEMENT

FRONT PANEL DOOR



HG-28B SOFT GREY



HG-068 WHITE



HG-121 ANTHRACITE



HG-237 GREY



HG-278 CAPPUCCINO



HG-538 SAND BEIGE



MATT-068 WHITE



MATT-86A SPANISH BEIGE



MATT-87A PERSIAN BLUE



MATT-88A LIGHT GREY



MATT-429 FUME



MATT-538 SAND BEIGE



**BOREAS
DESIGN**

MEASURE, PROJECT AND IMPLEMENT

MELAMINE FACED DOOR



M301-WHITE



M302-ANTHRACITE



M303-SAFIR OAK



M304-KAFKAS OAK



M305-BELEN

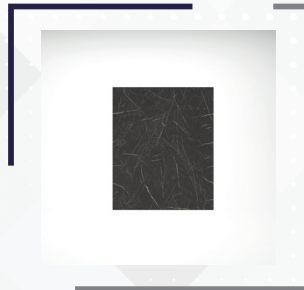

M306-LATIN MARBLE



M307-RETRO SILVER



M308-TUVALU



M309 CARBON GREY

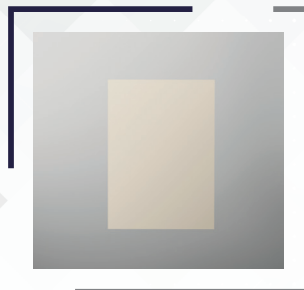

M310 SAND BEIGE



M311 ASH GREY



V312 MIST GREY



**BOREAS
DESIGN**

MEASURE, PROJECT AND IMPLEMENT

PAINTED DOOR



LAC101-ANT



LAC101-CRM



LAC101-GRY



LAC101-WHT

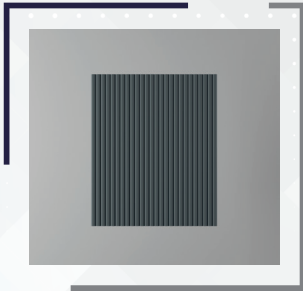

LAC102-ANT

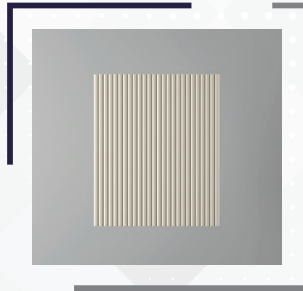

LAC102-CRM

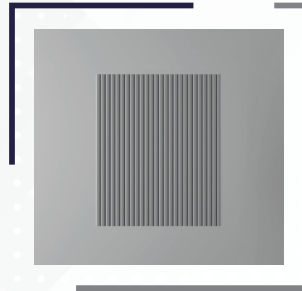

LAC102-GRY

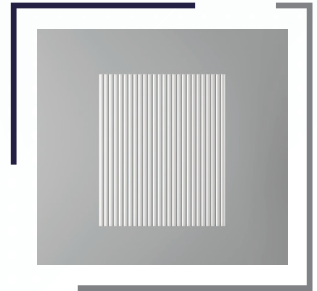

LAC102-WHT

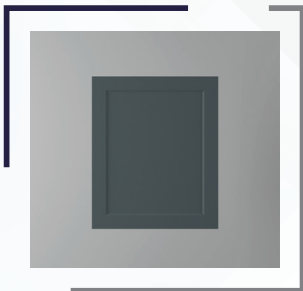

LAC103-ANT



LAC103-CRM



LAC103-GRY



LAC103-WHT



**BOREAS
DESIGN**

MEASURE, PROJECT AND IMPLEMENT

PAINTED DOOR



LAC104-ANT



LAC104-CRM



LAC104-GRY



LAC104-WHT

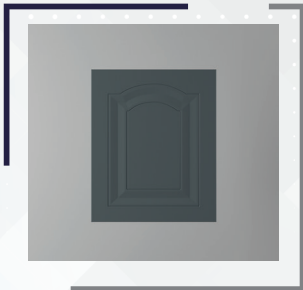

LAC105-ANT



LAC105-CRM



LAC105-GRY



LAC105-WHT

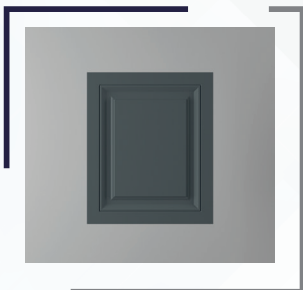

LAC106-ANT



LAC106-CRM



LAC106-GRY



LAC106-WHT



**BOREAS
DESIGN**

MEASURE, PROJECT AND IMPLEMENT

PAINTED DOOR



LAC107-ANT



LAC107-CRM



LAC107-GRY



LAC107-WHT

MODULAR KITCHEN INTRODUCTION TECHNICAL SPECIFICATIONS

- Our body colors are the color of standard snow white.
- Bodies are made of MDFLAM or CHIPBOARD with two sides covered with melamine in 18 mm E1 quality norms.
- Body backs are made of Mdfлам with one face covered with melamine in 5 mm E1 quality norms.
- All of the bodies are taped with 0.80 mm pvc tape.
- The backrests are manufactured as a plug-in system by opening the channels to the intervals of the body.
- Upper cabinets are mounted with daset hanger system or L hanger system.
- The heights of upper cabinet are 60 cm ,72 cm,90 cm, their depths are 35 cm, including the cover.The height of the lower cabinet is 72.6 cm, the depths of them are 58 cm, including the cover.
- Bodies are manufactured as disassembled. In the disassembled system, minifix is used as a connector element and an accessory package is available to combine each module.
- Each module is wrapped in the shrink nylon with the label of plastic corner protection
- Box Rail or tandem rail is used in drawer modules and the drawer body is included in the module.
- In the lift-up cover modules, Piston or HF mechanism are included in the module.
- In the modules with cover , 1 hinge with slowdown and 1 hinge without slowdown are included in the module.
- Aluminum profile is provided instead of pre-registration ,with sink and built-in oven modules.
- Devices in pictures are not included in the prices.
- Base, laminate countertop, skirting board and Joint Bar are priced separately.
- Laminate countertops are delivered without sink without opening the sink space.
- Additional panels must be ordered separately.
- Spoon holder , dustbin and the aluminum sheets under sink are priced separately.
- Module covers are divided into 4 groups as PAINTED DOOR - MELAMINE FACED - FRONT PANEL and there are many color alternatives.
- Handle holes are not opened on the covers.The handle is not included in price.